



TEREX®

TC22-2

MINI EXCAVATOR



The machine shown may include optional equipment.

Specifications

Operating weight	2010 kg
Engine power	12.0 kW (16.3 HP)
Bucket capacity	21 – 91 l
Digging depth	2.54 / 2.74 m
Reach	4.17 / 4.37 m

Features

- ▶ Extra-wide blade for dozer applications
- ▶ Top-mounted boom cylinders for perfect protection of cylinders and larger range of application
- ▶ Comfort cab with excellent visibility (canopy as option)
- ▶ Knickmatik® allows for working closely along walls
- ▶ Wide range of proven working tools

WORKS FOR YOU.™

SPECIFICATIONS

ENGINE

Manufacturer, model	Kubota, D902 Tier 4 final
Type	3-cylinder diesel engine
Bore x stroke	72 x 73.6 mm
Displacement	898 cm ³
Power rating acc. to ISO 14396 @ 2300 rpm	12.0 kW (16.3 HP)
Torque max. @ 1800 rpm	52.1 Nm
Air filter with safety cartridge and maintenance switch	
Cold-starting aid	Glow plugs

ELECTRICAL SYSTEM

Nominal voltage	12 V
Battery	12 V / 44 Ah
Generator	12 V / 40 A
Starter	1.4 kW
Lighting system:	1 work light front left on the cab / canopy (auxiliary headlamps optional)

TRANSMISSION

Two-stage hydrostatic travel drive with axial piston variable displacement motor and reduction gear, fully enclosed. "Straight-Travel" function. Travel brake valves for downhill travel

Travel speed, 1 st gear	2.2 kph
Travel speed, 2 nd gear	4.2 kph

Forwards and backwards respectively. Manual switching via button on dozer lever.

UNDERCARRIAGE

Torsion-proof welded design. Hydraulically retractable/extendable undercarriage provided as standard. Maintenance-free crawler-type undercarriage. Idler suspension with hydraulic crawler-chain tensioning. Sliding plate at the top

Range of adjustment, outside edge of crawler chains	990 - 1340 mm
Width rubber tracks (short pitch)	230 mm
Total length (undercarriage)	1490 mm
Number of rollers per side	4
Track width	760 - 1110 mm
Gradeability	max. 60%
Drawbar pull 1 st / 2 nd speed range	1400 / 780 daN

DOZER BLADE

Independent of drive train, sensitive control via separate hand lever

Width x height	1340 x 235 mm
Dozer cut below ground	160 mm
Dozer lift above ground	200 mm
Slope angle	25°

STEERING

Independent individual control of crawler chains, also counterwise. Sensitive actuation via manual levers, combined with pedals, foot rest on pedal console

SWING SYSTEM

Internally toothed ring gear	
Swing speed	0 - 9 rpm

SWING BRAKE

Hydrostatic drive, also acts as wear-resistant brake. Additional spring-loaded multi-disc brake. Considered as transport security



FLUID CAPACITIES

Fuel tank	27 l
Hydraulic system (incl. tank 21 l)	26 l

KNICKMATIK®

Lateral parallel adjustment of boom arrangement at full dig depth.

Angle of articulation / lateral adjustment left	59° / 414 mm
Angle of articulation / lateral adjustment right	60° / 555 mm

OPERATING DATA, STANDARD EQUIPMENT

Operating weight according to ISO 6016: Cab with 600 mm bucket, quick-attach system, 1 st additional control circuit, rubber tracks, including driver, full fuel tank	2010 kg
Operating weight according to ISO 6016: Canopy with 600 mm bucket, quick-attach system, 1 st additional control circuit, rubber tracks, including driver, full fuel tank	1930 kg
Transport weight: Cab, tank half full, with quick-attach system, w/out bucket	1885 kg
Transport weight: Canopy, tank half full, with quick-attach system, w/out bucket	1805 kg
Total length (travel position)	2853 mm
Total length (trailer transport position)	4133 mm
Total height (top of canopy / cab)	2277 / 2294 mm
Total height (travel position)	2673 mm
Total width (undercarriage)	990 - 1340 mm
Total width of uppercarriage	980 mm
Uppercarriage tail swing	1140 mm
Uppercarriage front swing	1440 mm
Working envelope, bucket heaped (also with 600 mm bucket):	
180°	2580 mm
360°	2883 mm
Swing clearance	446 mm
Reach max.**	4171 / 4368* mm
Digging depth max.**	2541 / 2741* mm
Loading height approx.**	2593 / 2734* mm
Highest reachable height**	3642 / 3772* mm
Bucket rotation angle	191°
Bucket digging force acc. to ISO 6015	18,850 N
Stick digging force acc. to ISO 6015	11,000 / 9720* N
Specific ground pressure:	
Excavator cpl.	0.30 daN/cm ²

* with dipperstick 1150 mm (optional)

** Dimensions apply to machine standing on level ground, but can be increased by tilting the machine using the blade.

HYDRAULIC SYSTEM

Pump capacity, max.	36.3 l/min
Working pressure	250 bar
Dual gear pump	
LS-control and load independent flow distribution (LIFD) for all working movements and travel drive	
Simultaneous independent control of all functions	
All excavator movements servo-controlled, ISO	
All functions are proportionally controllable	
Hydraulic oil cooler	
Full flow filtration through return filter	
Cylinders for boom, dipper arm and articulation with end position damping at both ends	
Bucket retract function with end-position damping	
Safety shutdown activated by exit barrier	
Additional control circuit as standard: Terex 'Fingertip' control (electro proportional) for additional control circuit for work attachments on right joystick, including holding function for continuous operation, actuation via rollers	
Additional control circuit with bypass for pressure-reduced return quantity	
Hydraulic power to the couplings:	
Pump capacity (pressure-controlled)	
@ 145 bar	36.3 lpm
@ 210 bar	21.1 lpm
Max. working pressure	210 bar

CAB (STANDARD)

Spacious, sound-insulated full-vision steel cab, FOPS*** (acc. to ISO 3449), ROPS and TOPS (acc. to ISO 12117) certified
Very good all-round visibility, lean vertical support members
Safety glass
Front window supported by pneumatic springs, slidable under cab roof
Fixed window part without frame which obstructs the forward view
Door with large access on left hand side
Foldable console on left hand side for large entry access
Right door as emergency exit
Matching locks of hood, ignition and tank cap
Central connector for electrical cable
Wiper washer with wiper for windscreen
Interior light, coat hook
Operator's seat (comfort version), fabric-covered: Longitudinal and back tilt adjustment Continuous weight adjustment as per operator's weight Safety belt
Armrests height adjustable without tools
Cables for radio installation kit
Preparation for antenna
Large storage compartment under the operator's seat
Heating (water) with 2-speed fan and 4 adjustable exhaust nozzles
Temperature controller in cab
Storage pocket behind the operator's seat
Storage compartment for mobile phone (near 12V outlet)
1 left-hand outside rear-view mirror, foldable in front of windshield
1 working floodlight front left as standard
Display, fuel gauge, hour meter and warning lights
Fuse box easily accessible from outside of the cab
Very good ergonomics
Ergonomically arranged dozer blade lever
Fast / slow switch on dozer blade lever
Yellow beacon, radio, immobilizer (anti-theft device), working floodlights prepared for optional installation

*** FOPS-approved only with skylight guard (optional)

CANOPY

Robust steel pipe construction. 4 support members for the best all-round visibility	
1 working floodlight front left	
FOPS (acc. to ISO 3449), ROPS and TOPS (acc. to ISO 12117) certified	
Operator's seat (standard version), imitation leather: Longitudinal and back tilt adjustment Continuous weight adjustment as per operator's weight Safety belt	
Large lockable storage compartment under the operator's seat	
Storage pocket behind the operator's seat	
Display, fuel gauge, hour meter and warning lights	
Easy and quick change of canopy to cab and vice-versa (< 1 hour)	
Yellow beacon, immobilizer (anti-theft device), working floodlights prepared for optional installation	
Reduction weight canopy	80 kg

CRANE TRANSPORT

Crane lifting beam for cab and canopy

SOUND LEVEL VALUES

Noise emission ambience L_{WA} cab / canopy	93 / 93 dB (A)
Noise emission cab L_{PA} cab / canopy	80 / 80 dB (A)
Sound level values measured in compliance with Directive 2000/14/EC and EN474	

VIBRATION VALUES

Effective values of acceleration for whole body	less than 0.5 m/s ²
Effective values of acceleration for hand-arm	less than 2.5 m/s ²
Vibration values in compliance with Directive 2006/42/EC and EN474	

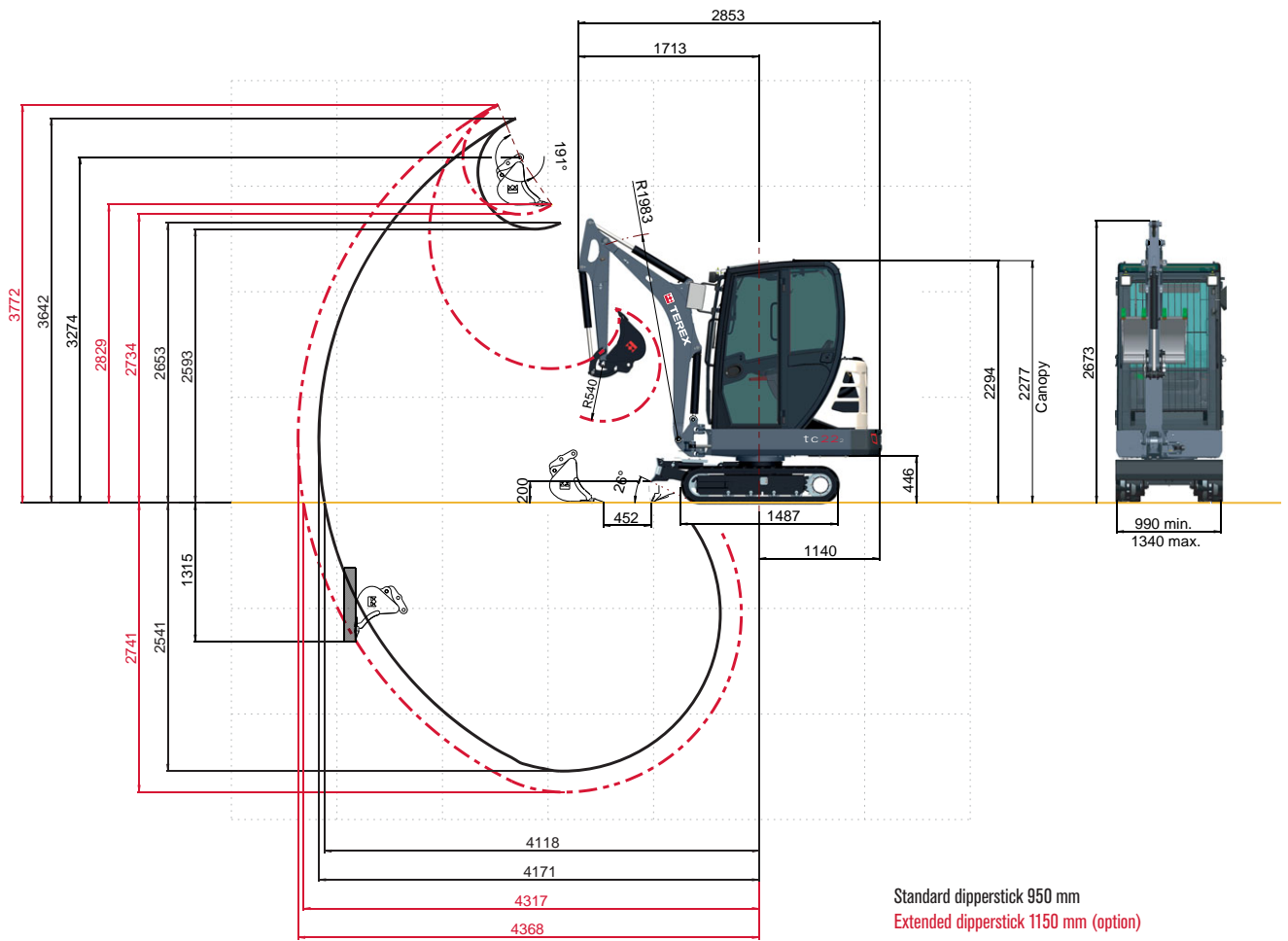

DIMENSIONS

Fig. 1, 2:
Excavation within the entire width of the machine

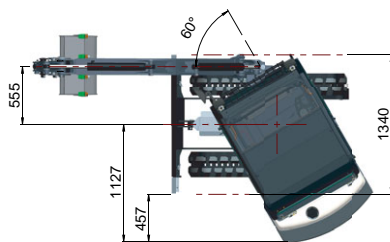

Fig. 3:
Transport position - trailer transport

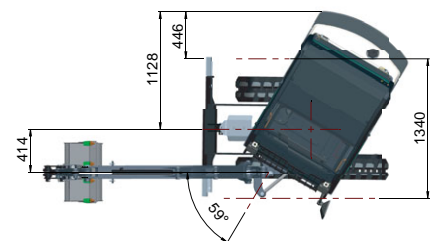
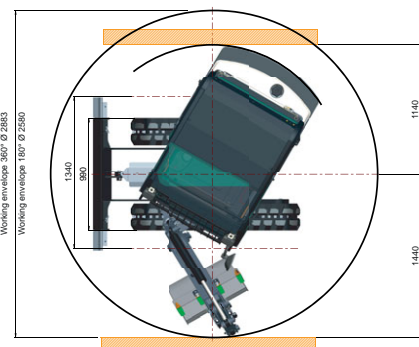
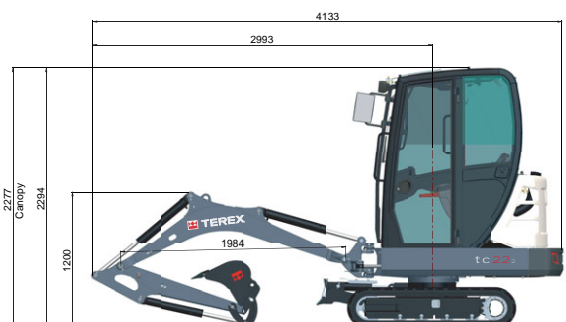









































Fig. 4:
Working envelope



LIFTING CAPACITIES

Bucket hinge height		Load radius from center of ring gear																			
Dipperstick 950 mm		1.5 m				2.0 m				2.5 m				3.0 m				3.5 m			
		UR	UE	UR	UE	UR	UE	UR	UE	UR	UE	UR	UE	UR	UE	UR	UE	UR	UE	UR	UE
																					
2.0 m		-	-	-	-	-	-	-	-	0.45	0.45	0.36	0.36	0.37	0.37	0.29	0.37	-	-	-	-
		-	-	-	-	-	-	-	-	0.45	0.45	0.36	0.36	0.37	0.37	0.27	0.37	-	-	-	-
1.0 m		-	-	-	-	0.79	0.79	0.47	0.75	0.54	0.54	0.35	0.53	0.43	0.43	0.27	0.42	0.35	0.35	0.21	0.33
		-	-	-	-	0.75	0.75	0.45	0.74	0.54	0.54	0.34	0.53	0.43	0.43	0.26	0.42	0.28	0.28	0.20	0.33
0.0 m		-	-	-	-	0.76	0.76	0.42	0.70	0.56	0.56	0.32	0.53	0.43	0.43	0.26	0.42	0.33	0.33	0.20	0.28
		-	-	-	-	0.60	0.60	0.41	0.70	0.42	0.42	0.31	0.53	0.32	0.32	0.25	0.42	0.33	0.33	0.19	0.28
-0.75 m		-	-	0.59	0.76	0.62	0.62	0.41	0.57	0.47	0.47	0.31	0.45	0.37	0.37	0.24	0.34	-	-	-	-
		-	-	0.56	0.74	0.60	0.60	0.40	0.57	0.47	0.47	0.30	0.45	0.37	0.37	0.23	0.34	-	-	-	-

Bucket hinge height		Load radius from center of ring gear																			
Dipperstick 1150 mm		1.5 m				2.0 m				2.5 m				3.0 m				3.5 m			
		UR	UE	UR	UE	UR	UE	UR	UE	UR	UE	UR	UE	UR	UE	UR	UE	UR	UE	UR	UE
																					
2.0 m		-	-	-	-	-	-	-	-	0.31	0.31	0.33	0.29	0.28	0.28	0.29	0.28	0.26	0.26	0.20	0.28
		-	-	-	-	-	-	-	-	0.31	0.31	0.29	0.29	0.28	0.28	0.28	0.28	0.26	0.26	0.16	0.28
1.0 m		-	-	-	-	0.63	0.63	0.44	0.60	0.44	0.44	0.31	0.43	0.35	0.35	0.25	0.34	0.29	0.29	0.19	0.29
		-	-	-	-	0.63	0.63	0.38	0.60	0.44	0.44	0.29	0.43	0.35	0.35	0.24	0.34	0.29	0.29	0.18	0.29
0.0 m		-	-	-	-	0.69	0.69	0.41	0.64	0.50	0.50	0.28	0.50	0.37	0.37	0.21	0.37	0.28	0.28	0.20	0.27
		-	-	-	-	0.54	0.54	0.38	0.64	0.50	0.50	0.27	0.50	0.37	0.37	0.21	0.37	0.28	0.28	0.17	0.27
-0.75 m		-	-	0.51	0.77	0.54	0.54	0.39	0.51	0.39	0.39	0.29	0.38	0.28	0.28	0.28	0.29	0.21	0.21	0.22	0.21
		-	-	0.50	0.77	0.54	0.54	0.34	0.51	0.39	0.39	0.26	0.38	0.28	0.28	0.20	0.29	0.21	0.21	0.22	0.21

All values in tons (t) were determined acc. to ISO 10567 and include a stability factor of 1.33 or 87% of the hydraulic lifting capacity. All values were determined with quick-attach system but without bucket. In case of mounted-on-work attachments, the deadweights of the work attachments must be deducted from the permissible operating loads

Working equipment: Rubber tracks

Abbreviations: UR = Undercarriage retracted, UE = Undercarriage extended

WORK ATTACHMENTS

BUCKETS

Bucket, QAS	250 mm wide, capacity 21 l, 27 kg
Bucket, QAS	300 mm wide, capacity 26 l, 30 kg
Bucket, QAS	400 mm wide, capacity 37 l, 35 kg
Bucket, QAS	500 mm wide, capacity 48 l, 41 kg
Bucket, QAS	600 mm wide, capacity 59 l, 46 kg
Ditch-cleaning bucket, QAS	1000 mm wide, capacity 91 l, 79 kg
Swing bucket, QAS	1000 mm wide, capacity 49 l, 79 kg

GRABS

Clamshell grab GL 1250, grab swing brake	set of shells 250 mm wide, capacity 45 l
Ejector	

OTHER WORK ATTACHMENTS

Hydraulic hammer	Cutting unit
Augers	Quick-change adapter for hydraulic hammer
Bolt-on load hook for bucket rod	Further work attachments available on request

OPTIONAL EQUIPMENT

CRAWLER CHAIN OPTIONS

Rubber tracks (long pitch), 230 mm wide

BOOM OPTIONS

Monobloc boom, with extended dipperstick 1150 mm

HYDRAULIC SYSTEM

Terex 'Fingertip' control (electro proportional) incl. second additional control circuit on left joystick, including holding function for continuous operation, actuation via rollers

Hose-rupture / load-retaining valves for boom and dipperstick cylinders

Quick couplings for control circuit for work attachments (hammer hydraulics) incl. open return

Supplementary set "Clamshell grab opening / closing", without quick couplings, for standard dipperstick

Quick couplings for 2nd additional control circuit

Quick couplings for supplementary set "Clamshell grab opening/closing"

Biodegradable hydraulic oil / ester-based HLP 68 (Panolin)

OPERATOR'S STAND

Operator's seat (standard version), imitation leather

CAB

Rain guard

FOPS - skylight guard

Lighting package: Cab-mounted working floodlight front right and rear right, boom-mounted working floodlight, yellow beacon

Radio set installation kit (speakers)

Fire extinguisher, ABC powder 2 kg

OTHER OPTIONAL EQUIPMENT

Mechanical quick-attach system

Crane lifting gear

Quick-attach system, mechanical (genuine Lehnhoff system), type MS01 or MS03

Safety package: hose-rupture / load-retaining valves for boom and dipperstick cylinders, fire extinguisher, immobilizer, motion alarm

Back-up alarm, signal-horn (can be switched off)

Special colour options

Immobilizer, transponder key

Further optional equipment available on request

www.terex.com/construction

Effective Date: April 2016. Product specifications and prices are subject to change without notice or obligation. The photographs and/or drawings in this document are for illustrative purposes only. Refer to the appropriate Operator's Manual for instructions on the proper use of this equipment. Failure to follow the appropriate Operator's Manual when using our equipment or to otherwise act irresponsibly may result in serious injury or death. The only warranty applicable to our equipment is the standard written warranty applicable to the particular product. Terex makes no other warranty, express or implied. Products and services listed may be trademarks, service marks or trade-names of Terex Corporation and/or its subsidiaries in the USA and other countries. All rights are reserved. "Terex" is a registered trademark of Terex Corporation in the USA and many other countries. Copyright © 2016 Terex Corporation (R1_010416) Ref. no.: TEREX852EN

Terex Compact Germany GmbH
Kraftwerkstrasse 4
D-74564 Crailsheim
Phone: +49 (0)7951 / 9357-0 Fax: +49 (0)7951 / 9357-671
construction@terex.com www.terex.com



TEREX®

WORKS FOR YOU.™